











Round Shape Rocker Switch PRL3-5 Series

SPECIFICATIONS

1. Rating: H: 10A, 125VAC / 6A 250VAC
6(2)A 250VAC T125
T: 16A, 125VAC / 10A 250VAC
1/3HP 125~250VAC T105
2. Contact resistance: 20mΩ Max.
3. Insulation resistance: 100MΩ Min. at 500VDC
4. Dielectric strength: 1,500VAC for 1 minute
5. Safety approval: 

PART NUMBERING SYSTEM

{1} PRL3-5	{2} 	{3} Rocker / Housing	{4} 	{5} 
{1} Series: PRL3-5: Round shape rocker switch				
{2} Circuit: A: 2P ON-OFF B: 3P ON-ON C: 3P ON-OFF-ON D: 2P (ON)-OFF E: 4P with LED I: 2P Indicator L: 3P Illuminated				
*(): Momentary				
{3} Color: B: Black, G: Green, H: Gray, I: Ivory, R: Red, S: Slate gray, W: White, Y: Yellow				
{4} Stamp: 0:  1:  2:  3:  4:  5:  6:  7: 				
{5} Rating: H: 10A T: 16A				

DIMENSIONS (Unit:mm)

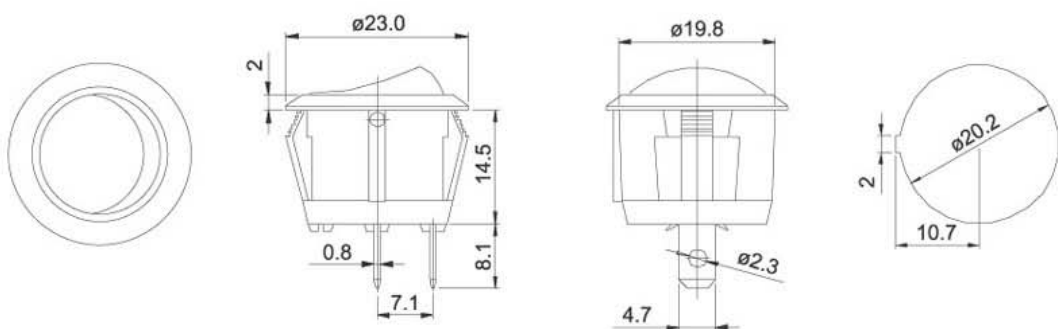

OPTIONS:

